

THE PROPERTY OF THE DRAWING IS ESTABLISHED BY LAW. IT IS FORBIDDEN TO PRODUCE OR SHOW IT TO THIRD PARTY, WITHOUT A WRITTEN AGREEMENT.

Item	Name	Q.ty
1	05.01.005.01.10	1
2	05.01.005.07	1
3	05.02.005.03	1
4	M.8x26.6N	1

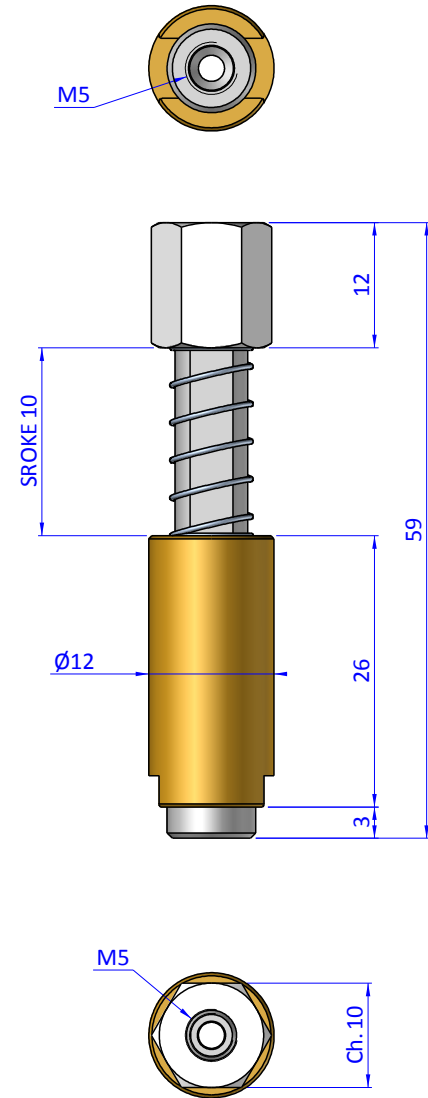
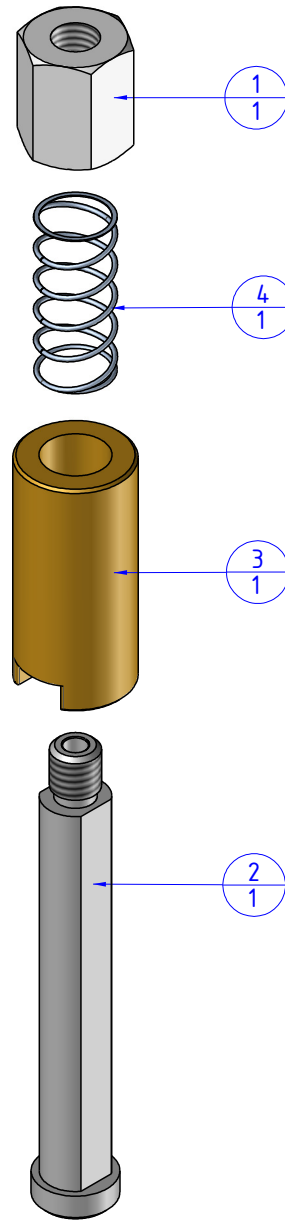

Format A3

UNI 936-76

FP SERVICES AUTOMATION		DESIGNED FROM FPSERVICES		REVIEW A
GENERAL TOLERANCE UNI - ISO 2768 CLASSE f		DATE 13/02/2019	WEIGHT 0,031kg	
DESCRIPTION CA.05.02.006		CODE CA.05.02.006		